

### 1. Unpacking the System

Inspect the chassis to see whether the appliance has been damaged in any way. If the appliance appears to be damaged, please contact Nozomi Networks support at: [support@nozominetworks.com](mailto:support@nozominetworks.com).



**Box contents:**

- Nozomi Networks NSG-H / HS Guardian appliance
- 2x Rack Mount Ears
- 8x Flat head screws for fixing rack mounting brackets
- 8x M5 screws for rack mounting
- 2x Rack rails
- 1x Grounding cable
- 2x RJ45 Cat.6 straight cable (2m.)
- 1x RJ45 Console cable
- 2x Power chords

### 2. Setup precautions and considerations

Please follow the *General Safety Guidelines* included in the box to prevent potential property damage, personal injury or even death.

**Furthermore, observe the following rules:**

- Before performing any of the following procedures, ensure that power has been removed from the AC or DC circuit.
- Read the installation instructions before you connect the system to its power source.
- Warning: To prevent the system from overheating, do not operate it in an area that exceeds the maximum recommended ambient temperature of: 40°C (104°F).

<b>Operating Environment</b>	Temperature: 0 – 40°C (32 – 104°F) Humidity: 20 – 90 % RH
<b>Storage Environment</b>	Temperature: -10 – 70°C (14 – 158°F) Humidity: 5 – 95 % RH @ 55°C

### 3. Unbox the appliance

Rack mounting brackets and their mounting screws are included in the pizza box on the side of the package.

- Affix each bracket to the appliance, using four of the provided screws

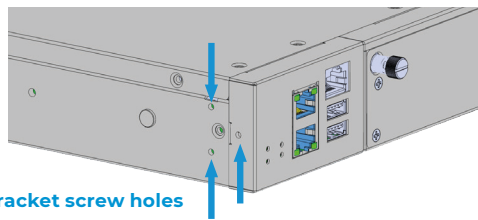

### 4. Rack Mounting

You can now mount the appliance in a standard 19" rack. Nuts and bolts for square holes are included in the box.

*For detailed rack mounting instructions, follow the specific guide you'll find in the box.*



### 5. Grounding

A reliable ground must be maintained at all times. To ensure this, the rack itself should be grounded and the appliance chassis should be connected for grounding to the rack via the provided appliance grounding cable.

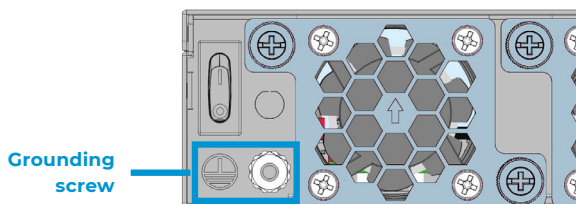

### 6. Connecting management port

Connect the management port (MGMT) (1) to the designated network switch or equipment. One RJ45 cable is included in the box for this purpose.

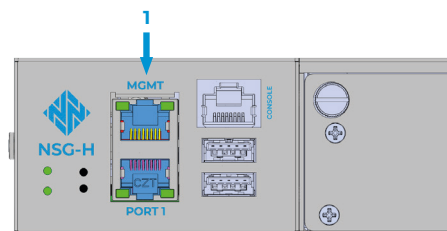

## 7. Connect monitoring ports

Plug the SFP modules into the slots if needed.

Connect monitoring ports (2) to the proper network mirror sources as needed.

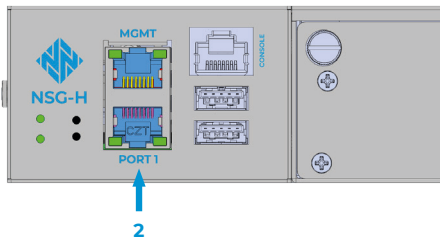

## 8. Connect the power cables

Connect both the power cable to the appliance, then to the power supply.

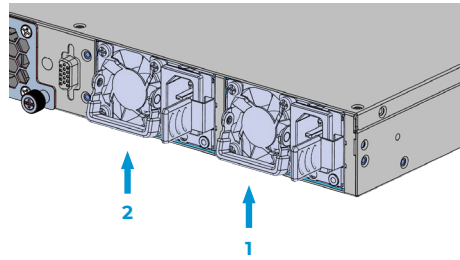

## 9. Power ON

Turn on the appliance by switching the power switch on the back to the position 'I' (on).

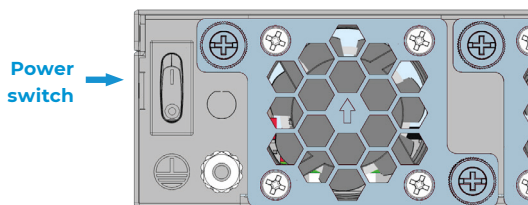

## 10. Connect Serial Console

Attach to the serial console port using the RJ45 Console port on the front of the appliance with a Null Modem cable:

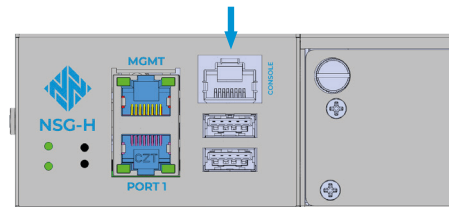

Connect to the serial console using 9600 bauds and no parity bit set.

## 11. Documentation

Continue the setup using *User Manual, Chapter 2: Installation*.

You can find the manual at:



<https://support.nozominetworks.com/manuals>



You will need a Nozomi Networks support account to view the manual.

You can request access credentials at:



<https://www.nozominetworks.com/support/>

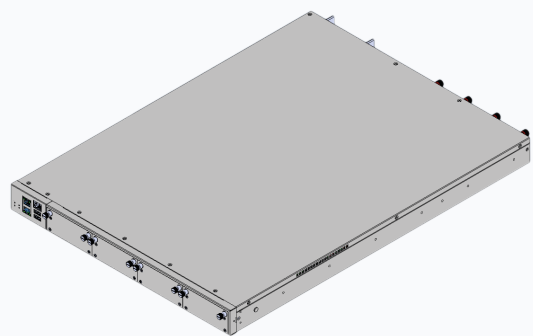

Nozomi Networks  
NSG-H / HS Guardian appliance